

**INSTRUCTION**

**and**

**MAINTENANCE MANUAL**

**for**

**Dosimeter Ratemeter CD V-736**

**Dosimeter CD V-746**

**Dosimeter Ratemeter Charger CD V-756**



**CINCINNATI DIVISION**

**CINCINNATI, OHIO**

## TABLE OF CONTENTS

	PAGE No.
Introduction .....	1
Operation of the Instruments.....	1
Zeroing the Meters.....	1
Reading the Meters.....	3
The CD V-736 Ratemeter.....	3
The CD V-746 Dosimeter .....	5
Meaning of the Readings .....	5
Probable Acute Effects of Radiation.....	6
Maintenance (Table of Contents).....	7

## LIST OF ILLUSTRATIONS

FIGURE	PAGE No.
1 Meter Held in Zeroing Position on Charger..	2
2 Ratemeter Scale with Hairline Indicator at Zero .....	2
3 Ratemeter Showing a Dose Rate Reading of 33 Roentgens/Hour.....	3
4 Upper Scale Ratemeter Reading Showing Approximately 10 Roentgens/Hour.....	4
5 Lower Scale Ratemeter Reading of 7.3 Roentgens/Hour .....	4
6 A Dosimeter Reading of 125 Roentgens.....	5

## INTRODUCTION

The instruments described in this manual can provide you with vital information about fallout radiation in the event of nuclear attack.

The instruments are not protective devices. Special shielding—a fallout shelter—is needed if you are to be protected from fallout radiation which can cause serious damage to living tissue.<sup>1</sup> But the instruments can be used as a type of “radiological ruler” to measure the degree of danger you face, making it possible for you to take certain actions in or about your home that might save your life.

Science has learned much in recent years about fallout radiation—a silent “weapon” that could threaten more Americans than the blast and heat from nuclear explosions if our Nation is ever attacked. Additional discoveries about the nature of fallout probably will make the instruments described in this manual even more valuable to you than they are today.

No person can make logical decisions if he must do it in ignorance of certain essential information. In a war emergency, the most critical personal decisions and the most essential information could be related to fallout radiation.

## OPERATION OF THE INSTRUMENTS

The bronze ratemeter (CD V-736) is used to measure the intensity (dose rate) of radiation at a specific time. The blue dosimeter (CD V-746) is used to measure the total amount of radiation accumulated over a period of time.

The bronze charging unit (CD V-756) is an accessory instrument used to prepare the ratemeter and the dosimeter for use. Also, if properly used, the light recessed in the “charging contact” of the charger may be used to illuminate the scales of the ratemeter and dosimeter, facilitating the reading of these instruments.

The operation of the ratemeter and the dosimeter is a two-step process:

- (1) Zeroing (charging) the meters, and
- (2) reading them.

## ZEROING THE METERS

The CD V-736 must be zeroed each time it is used. The CD V-746 does not have to be zeroed as frequently, but should be checked periodically during storage. The CD V-746 should be zeroed, or a record made of the scale reading, before you want to start using it (for example, after receiving warning of an enemy attack). From that point on it can be read as often as desired without first zeroing the instrument. In fact, zeroing the CD V-746 a second time will erase your record of the total amount of radiation accumulated.

The CD V-756 dosimeter charger is used to set the CD V-736 and CD V-746 at zero.<sup>2</sup> It has a “charging contact” and a “down-scale/up-scale” control for setting the hairline indicator in each meter at zero. The charger is powered by a single 1½ volt “D” cell flashlight battery which operates the charging circuit and the light for illuminating the meter scales. No tools are required to change the battery or the light bulb, and there are no internal adjustments to be made to the charger.

<sup>1</sup> See The Family Fallout Shelter, MP-15, Office of Civil and Defense Mobilization, Battle Creek, Mich.

<sup>2</sup> Arrangements may be made with local civil defense offices to use a CD V-750 charger to zero the dosimeter. However, this arrangement would not be practical in an emergency to zero the ratemeter each time before use.

## WARRANTY

The Bendix Corporation guarantees Bendix dosimeter-ratemeters and charging units against defects in workmanship and material for a period of 90 days from date of delivery to the customer. This guarantee is contingent upon the inoperative unit being returned to Bendix Corporation, 3130 Wasson Road, Cincinnati 8, Ohio, within this period, with all transportation charges prepaid, and covered by a detailed written explanation enumerating the points of defect.

The extent of the liability that the Bendix Corporation assumes under this warranty is limited to the free repair or replacement of the dosimeter, ratemeter and charging unit or any component parts thereof, except as to bulbs and batteries, at the option of Bendix; all such instruments are subject to inspection at our plant and the right to final decision as to responsibility is reserved by Bendix.

The warranty shall not apply in any instances where there is evidence of damage by accident, misuse, or alteration.

We reserve the right to effect changes in design on dosimeters, ratemeters, and charging units without incurring any obligation to similarly change the design of, or modify, or add improvements to any instruments purchased prior to the date of engineering change.

This warranty supersedes, and is in lieu of, all other warranties, expressed or implied, and no representative or person is authorized to assume for Bendix, any other liability in connection with the sale of this instrument.

To zero either the CD V-736 or the CD V-746, place the end of the meter opposite the pocket clip over the charging contact on the CD V-756 dosimeter charger. (See fig. 1.) Press down gently and the light will come on showing the location of the hairline indicator on the meter scale. (At times the indicator may be off the scale and out of view before adjustment.) By pressing harder, contact is made with the charging circuit, and the hairline indicator can be moved across the meter scale by turning the charger down-scale/up-scale control in the proper direction. Adjust the hairline indicator until it is over the zero mark on the meter scale. (See fig. 2.) Remove the meter from the charging contact. Check the meter reading immediately to see that the indicator has not shifted. If it has, zero the meter again. It may require practice to zero the meter properly.

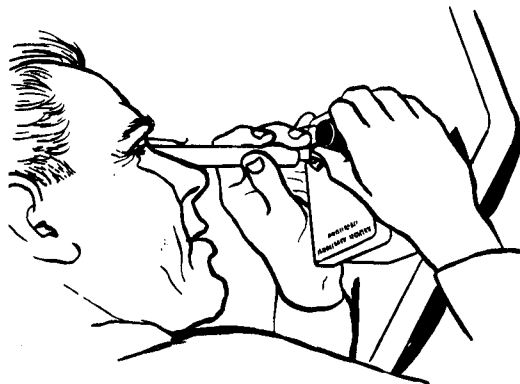

FIGURE 1. — METER HELD IN ZEROING (CHARGING) POSITION ON CHARGER CD V-756

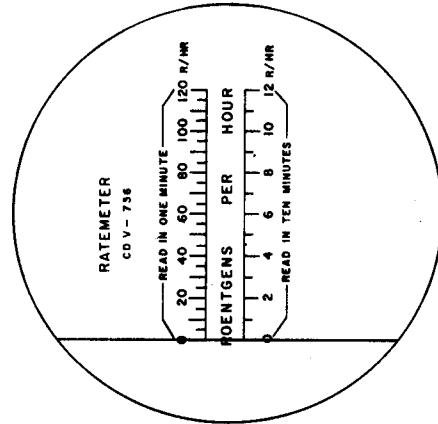

FIGURE 2. — RATEMETER SCALE WITH HAIRLINE INDICATOR AT ZERO

## READING THE METERS

Illumination required to read the CD V-736 or the CD V-746 may be provided by a light bulb, flame of a match or cigarette lighter, or by the light under the charging contact of the dosimeter charger. If the latter method is used, press the meter *gently* on the charging contact. If you press down too firmly, contact will be made with the charging circuit, and the meter reading may be changed or completely lost.

Although these instruments are ruggedly constructed, dropping them could change the readings. If this happens to the ratemeter, repeat the measuring procedure described below. If it happens to the dosimeter, reset the hairline indicator to the reading that was on the scale before the instrument was dropped. (It is advisable to keep a written record of dosimeter readings so that measurements are not lost through mishaps.)

## The CD V-736 Ratemeter

The readings of the CD V-736 are based upon how far the hairline indicator moves during a given period of time. Therefore, all readings must be timed accurately. If there is radiation present, the hairline indicator will begin to move as soon as the instrument is removed from the charging contact, so you must start your timing immediately. Expose the meter in a suspected radiation area for ONE MINUTE. Immediately read the radiation rate on the UPPER SCALE. (Figure 3 shows an example of such a reading—33 roentgens per hour (r/hr).)

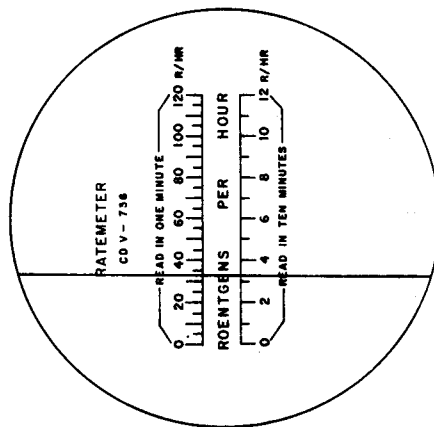

FIGURE 3. — RATEMETER SHOWING A DOSE RATE READING OF 33 ROENTGENS PER HOUR

Note that the scale on the CD V-736 goes up to 120 r/hr. However, by use of simple calculations the meter can be used to measure radiation dose rates much higher than this.<sup>3</sup>

Be careful in making radiation measurements with the CD V-736 that you do not endanger your health in the process through overexposure to radiation. If you can possibly avoid it, don't stand in an area suspected of having a high radiation rate while exposing the meter for measuring purposes. If you have a protected location, such as a fallout shelter, leave the shelter briefly to place the meter in the suspect area, return to the shelter, and then

<sup>3</sup> Should the reading exceed 120 r/hr, expose the meter to radiation for 30 seconds rather than one minute. Then multiply the reading on the upper scale by 2 to get roentgens per hour. If a very high radiation level is suspected, it is advisable to expose the meter for only 15 seconds and then multiply the reading on the upper scale by 4 to get roentgens per hour. This latter method makes it possible to measure dose rate at up to 480 r/hr with the CD V-736.

go back to get the meter at the proper time and take it into the shelter for reading. Another method would be to fasten the meter to a pole and push it out to the suspect area while you remain protected inside the shelter. Then retrieve the meter at the proper time and read it.

The radiation dose rate may be rather low, making it difficult to get an accurate reading by using the upper scale after the ratemeter has been exposed for one minute. (See figure 4.) In such a situation, rezero the meter, expose it for 10 minutes, and read the LOWER SCALE.<sup>4</sup> Figure 5 shows a lower scale reading identical in roentgens per hour to the reading in figure 4—but much easier to read.

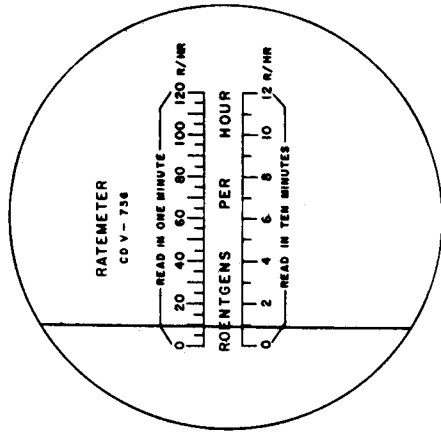

FIGURE 4. — UPPER SCALE RATEMETER READING SHOWING SLIGHTLY LESS THAN 10 R/HR. (METER EXPOSED ONE MINUTE TO RADIATION)

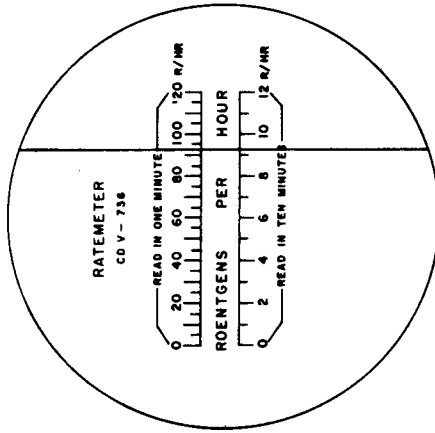

FIGURE 5. — LOWER SCALE RATEMETER READING OF 9.3 R/HR. (METER EXPOSED 10 MINUTES TO RADIATION)

<sup>4</sup> It is also possible to make accurate readings of low radiation dose rates by changing the period of meter exposure, reading the lower scale, and doing simple division. For example, by exposing the meter to radiation for 20 minutes and dividing the reading on the lower scale by 2, you will get a reading of roentgens per hour. To make a still lower reading, expose the meter for 100 minutes and read the lower scale as though decimal points have been placed to the left of each single-digit number (.2, .4, .6, .8) and in the middle of the two-digit numbers (1.0, 1.2).

## The CD V-746 Dosimeter

The CD V-746 is a high-range radiation dosimeter with a scale graduated from 0 to 600 roentgens. After following instructions for the CD V-746 given in "Zeroing the Meters," no further calculations or adjustments are required in using the dosimeter. Simply hold it to a source of light to see what the hairline indicator on the scale shows to be the total amount of radiation accumulated.

The dosimeter reading in figure 6 shows that the instrument has been exposed to a total dose of 125 roentgens since the time it was zeroed.

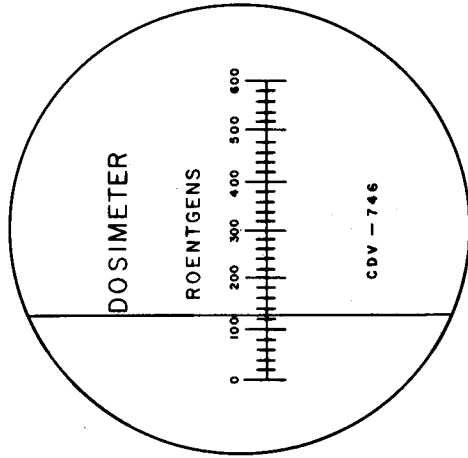

FIGURE 6. — A DOSIMETER READING OF 125 ROENTGENS

Even under normal peacetime conditions the hairline indicator may drift up-scale very slowly. This should not be more than 60 roentgens on the scale over a period of a year. Because of this possible drift, the instrument should be checked periodically and rezeroed, if necessary.

## MEANING OF THE READINGS

To benefit most from the information obtained from these instruments you must have some understanding of the biological damage resulting from nuclear radiation. The precise effects of nuclear radiation are very complex.<sup>5</sup> However, a complete understanding of them is not required to use your instruments.

Much has been said about the long-range effects from exposure to radiation—increased incidence of leukemia, shortening of the life span, and genetic implications. No doubt radiation exposure will result in some increases in the small percentages of such occurrences normally expected. Other effects of radiation, called acute effects, can result in sickness or death in a relatively short time. In the event of a nuclear attack on this country it is these acute effects that must be dealt with first, and the equipment you have purchased can help you do this.

Scientists generally agree on the amount of radiation damage the body can sustain without causing sickness and death. There are so many variables concerning how radiation will affect you that precise determination of the effects of radiation cannot be made. The total amount of radiation damage you can incur before becoming ill will depend upon such variables as the

<sup>5</sup> See The Effects of Nuclear Weapons, U. S. Department of Defense and the U. S. Atomic Energy Commission, and Radiation Physics and Bomb Phenomenology, TB-11-22, Office of Civil and Defense Mobilization.

duration of the exposure, your body's ability to repair the damage, your general health, age, and vigor. These variables make it difficult to set exact figures for the individual, but ranges that will apply generally can be given.

Perhaps the most important points to remember are (1) for a dose of 100 roentgens received in a few days there probably will be no obvious effects, and you will be able to continue your normal routine; (2) when the short-term exposure exceeds about 200 roentgens you will become sick and need medical assistance; and (3) a short-term exposure of about 600 roentgens will almost certainly cause death.

### Probable Acute Effects of Radiation<sup>6</sup>

<i>Short-term, whole-body exposure in roentgens</i>	<i>Probable Effect*</i>
0-100	No obvious effects
100-200	Minor incapacitation
200-600	Sickness and some deaths
Over 600	Few survivors

\* The long-range effects, such as shortened life span, decreased resistance to disease, etc., are not considered here.

These effects would be modified considerably if the dose were received over a long period. A short-term dose of 600 roentgens probably would be fatal, but it would not cause death or have any noticeable external effects if the exposure were gradually acquired over a much longer period of time—months to years, for example. The body repairs some of the damage if the exposure is received gradually, and larger doses can be accepted before the individual becomes sick or before death occurs.

As an example of how this might be applied in an emergency situation: If a person restricts his total dose of radiation to 200 roentgens for the first month of exposure, 25 roentgens per week for the next 5 months, and 10 roentgens per week thereafter for the next 6 months, he would have little, if any, radiation sickness or impairment of ability to work.

You must remember that any radiation received—no matter how little—is harmful. Your body can never repair all the damage. Take every precaution necessary to keep your exposure as low as possible.

In applying the term "dose rate" (in roentgens per hour) and "dose" (in roentgens), an analogy may be useful. Think of roentgens per hour as you do miles per hour. The ratemeter, when exposed where you are located, indicates the number of roentgens per hour you are receiving, just as the speedometer of an automobile indicates the number of miles per hour you are traveling. When you see your speedometer showing too high a speed for road conditions, you slow down to protect yourself. When the ratemeter indicates too high a radiation rate, you should enter and stay in a shelter to protect yourself. Both instruments are related to time. Driving 60 miles an hour for one hour will carry you 60 miles, and if you are in a location where the dose rate is 60 roentgens per hour and remain there for one hour you will have an exposure of 60 roentgens.

Radiation levels, like speed levels, change under certain conditions. The dose rate increases while fallout is being deposited, reaches a peak value, and then decreases over a period of time—rather rapidly at first but more slowly as time passes. That's why a dosimeter is needed in measuring radiation. Think of it this way: It would not be practical to figure the number of miles you had driven if your speed had varied and you had only a speedometer in your car. That's why every car has an odometer which records the total number of miles driven. Similarly, it would not be practical to figure your total radiation dose if the dose rate had varied and you had only a ratemeter for measuring purposes.

The ratemeter shows you how much radiation is being received at a given time. The dosimeter shows you how much total radiation has been received.

<sup>6</sup> See Emergency Exposures to Nuclear Radiation, TB-11-1, and Medical Aspects of Nuclear Radiation, TB-11-24, Office of Civil and Defense Mobilization.

# MAINTENANCE

## TABLE OF CONTENTS

General Description .....	PAGE 8
Theory of Operation .....	8
Installation .....	8
Operation .....	9
Operator's Maintenance .....	9
Storage .....	10
Preventive Maintenance .....	10
Trouble Shooting .....	10
Corrective Maintenance .....	11
Equipment .....	11
Component Check .....	11
Parts List .....	13
Preventive Maintenance for Ratemeter CD V-736 and Dosimeter CD V-746 .....	14

## LIST OF ILLUSTRATIONS

1 Initial Condition .....	8
2 Reading Position .....	8
3 Charging Position .....	8
4 Top View .....	12
5 Component Layout .....	12
6 Circuit Diagram .....	13

## GENERAL DESCRIPTION

The DOSIMETER CHARGER CD V-756 is a self contained battery-operated instrument. This instrument will charge to zero any self-reading dosimeter which has a standard military or O.C.D.M. charging end. The CD V-756 charging unit is specifically designed for use with MILITARY, O.C.D.M. and COMMERCIAL DOSIMETERS.

The charger is contained in a two-part metal case, 4 by 4 by 2 inches, held together with a single captive screw. The charging contact is located in the upper left-hand corner and the voltage control knob in the upper right-hand corner. The charging contact has a screw-on cover which is permanently attached to the case.

## THEORY OF OPERATION

(See Figure 5)

The circuit is powered by a 1.5-volt battery (2). Pressure applied to the charging contact closes the switch and the bulb lights (1). Also the transistor (Q-1) sets up an oscillating signal which is amplified by the transformer (T-1) and rectified by the diode (D-1). Thus a potential of 220 volts maximum is available at the charging pin. The dosimeter to be charged must be pressed down so that it closes the circuit between the charging pin and ground. Resistor (R-2) varies the potential of the charging pin.

## INSTALLATION

Remove charger and battery from package. Loosen the captive screw on the bottom of the charger and remove the cover. Insert the battery, carefully observing the polarity markings. Tighten the bulb in its socket. Replace the cover oriented so that the rubber pad is over the battery and tighten the captive screw. Remove the cap from the charging contact, and the charger is ready for operation.

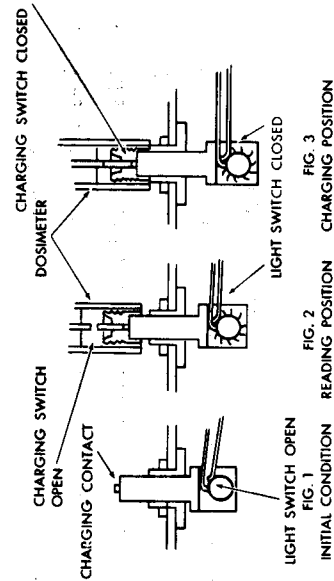

FIG. 1 INITIAL CONDITION  
FIG. 2 READING POSITION  
FIG. 3 CHARGING POSITION

## OPERATION

TO CHARGE (ZERO) DOSIMETER (see Figure 3)

1. Place dosimeter on charging contact and PRESS DOWN FIRMLY.
2. Rotate voltage control until hairline image on the dosimeter scale is at zero.
3. Remove dosimeter and check reading using charger light (rezero if necessary).

TO READ DOSIMETER (EXCEPT CD V-138 & CD V-736 BY USING CHARGER LIGHT (see Figure 2)

1. Place dosimeter on charging contact and PRESS DOWN GENTLY until charger light illuminates the scale.  
CAUTION: If the dosimeter is pressed down too hard (too far), the reading will be altered.
2. To read CD V-138 & CD V-736 or any dosimeter of less than 0-5R range (see Figure 2), turn voltage control all the way "up scale" then read dosimeter as above.

## OPERATOR'S MAINTENANCE

### GENERAL

#### A. TO OPEN CASE

Loosen captive screw in bottom of charger and remove cover and lock assembly.

#### B. TO REPLACE BULB

1. Open case
2. Remove bulb
3. Replace with spare bulb (No. 131 bulb or equivalent).

#### C. TO REPLACE BATTERY

1. Open case
2. Lift out battery
3. Replace with 1½-volt D-cell NEDA type-13 or equivalent.

CAUTION: Orient battery as shown on battery orientation label at bottom of battery compartment and replace cover so that the rubber pad is over the battery.

#### D. CARE OF CHARGING CONTACT

Always keep the protective cap on the charging contact when the charger is not in use.

The clear plastic surfaces of the charging contact should be dry, clean and free of finger prints. A soft cloth free of grit, dirt, lint or moisture may be used to clean the plastic surfaces.

CAUTION: Do not use solvent or cleaning fluid to clean plastic (solvents can craze plastic).

## STORAGE

- A. Remove the battery from chargers to be stored for more than 2 months.
- B. Store with case closed and protective cap on charging contact.

## PREVENTIVE MAINTENANCE

- A. Clean battery contacts to bright metal with steel wool or equivalent.
- B. Check battery and bulb (replace as required).
- C. Check electrical operation.

## TROUBLE SHOOTING

If instrument does not appear to operate normally, it may be for one of the following reasons:

ABNORMAL CONDITION	PROBABLE CAUSE	CORRECTIVE ACTION
Light weak or fails to go on when charging contact is depressed	Weak Battery Dirty (Corroded) battery or light switch springs Loose light bulb Burned out bulb	Replace Battery Clean battery and light switch contacts to bright metal with steel wool or equivalent Tighten bulb in socket Replace bulb
Shadows appear on dosimeter scale	Dirt on charging contact Dirt on either end of dosimeter	Clean charging contact Clean dosimeter and eye-piece with clean dry lint-free cloth
Fiber image unsteady (jittery movement of fiber image when rotation of voltage control)	Poor contact of dosimeter with outer aluminum sleeve of charging contact	Keeping the dosimeter vertical, move dosimeter sideways to make the charging contact sleeve touch the inside wall of the dosimeter charging recess
Light illuminated scale, but fiber image does not appear on scale with rotation of voltage control	Poor contact of dosimeter with outer aluminum sleeve of charging contact Dirt or moisture on charging end of dosimeter or charging contact Dirty light switch spring contacts Faulty circuit component or connections	Same as above Clean or dry faulty part Clean switch contacts See schematic, parts list and test voltages

## CORRECTIVE MAINTENANCE

If the charger does not operate normally after the preceding corrective action, the following tests must be made to isolate the trouble.

### EQUIPMENT

Volt-Ohmmeter—20,000 ohms/volt type  
Electrostatic Voltmeter

All measurements are to be made with the voltage control turned fully "Down Scale" and the cap removed from the charging pedestal. Refer to Figure 6 for Check Points.

### COMPONENT CHECK

CHECK POINTS	READING	CHECK POINTS	READING
1-5	220 Volts Min.*	6-7	100 Ohms Max.**
1-5	11-16 Megohms	7-6	10 Megohms Min.**
1-2	1.5 Volts*	7-6	10 Megohms Min.**
1-3	1 Volt*	3-4	6 Ohms**
1-4	1.2 Volts*	4-6	150 Ohms**
2-4	10 Ohms**	1-8	5 Megohms Max.**
2-3	4 Ohms**		

\* S-1 Closed; used electrostatic voltmeter to measure output voltage 1-5.

\*\* S-1 Open.

The above tests will check the switch, transformer, diode, and resistor R.1. To check the transistor, remove the light bulb and disconnect the emitter lead E. Make the following tests:

TEST POINT	READING
Base to Emitter	50 Ohms Max.
Emitter to Base	100K Ohms Min.
Base to Collector	50 Ohms Max.
Collector to Base	100K Ohms Min.

To check the potentiometer, R-2, measure the resistance across 5-9 with the voltage knob turned fully clockwise. This resistance should be 8 Megohm minimum with the meter leads connected to give the highest reading.

Capacitor C-1 may be checked by disconnecting the lead to the capacitor at test point 10. A good capacitor will show infinite resistance to ground. Capacitor C-2 is checked in similar manner after disconnecting at test point 5.

Replace any component which does not give readings within above limits.



**PARTS LIST**

CIRCUIT SYMBOL OR ITEM No.	DESCRIPTION	BENDIX PART No.	MFR. SPARES <sup>9</sup> SEE NEXT PAGE
Q-1	Transistor	B001466	1
R-1	Resistor—4.7 Meg. Ohms ½ watt, ± 10%	B000705-475	2
R-2	Resistor—Variable 10 Meg. Ohms	B001279-3	3
C-1 & C-2	Capacitor—.005 Mfd., 500 Volts	C000865-32	4
T-1	Transformer	B633096-1	5
D-1	Diode—400V Peak Inverse Voltage	B001465-1	6
1	Bulb—Type 131	A000971-1	7
2	Battery—NEDA Type 13	A000665-1	8
3	Light Tube Assembly	C633306-1	5
4	Case Assembly	C633325-1	5
5	Cover Assembly**	C633295-1	5
6	Knob	A633090-1	5
7	Cap and Chain	B633303-1	5
8	Battery Contact Positive	A633294-1	5
9	Spring—Lower	A633298-1	5
10	Spring—Upper	B632726-2	5
11	Support Block	D633091-1	5

\*\* Consisting of Silk Screened Cover, Battery Orientation Label, Gasket and Negative Battery Contact.

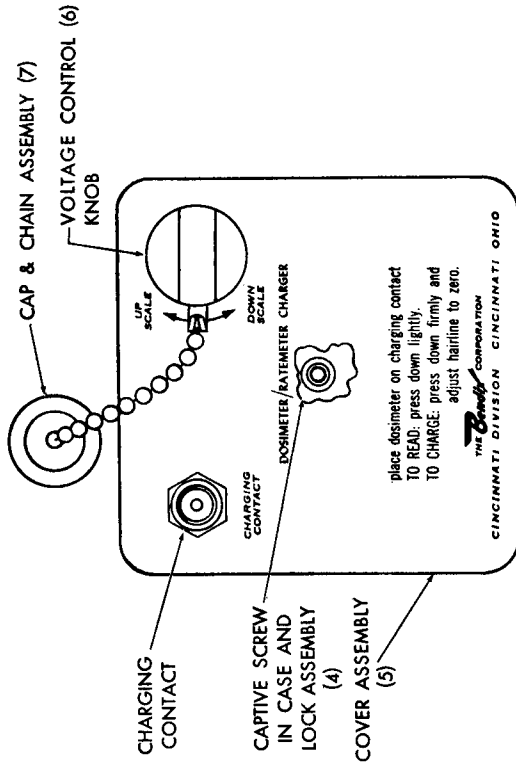

FIGURE 4

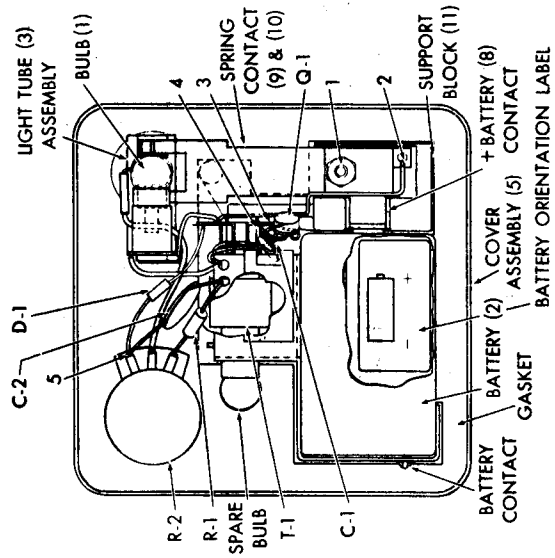

FIGURE 5

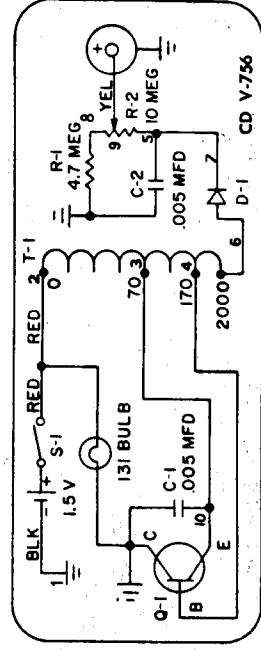

FIGURE 6

- 1 Tung-Sol Electric, Inc., Newark 4, N. J., No. TS600RF.
- 2 International Resistance Co., Philadelphia, Pa.
- 3 Clarostat Mfg. Co., Inc., Dover, N. H., Series 47.
- 4 Sprague Electric Co., North Adams, Mass., Type RMC-B.
- 5 Manufactured by The Bendix Corporation, Cincinnati, Ohio.
- 6 Hughes Aircraft Co., Los Angeles 45, Calif., Type XYTAN No. 40.
- 7 G. E. Co., Cleveland, Ohio.
- 8 National Carbon Co., 1½ volt (Eveready) "D" cell.
- 9 Recommended quantity for groups of 5 instruments for plant and field maintenance for yearly periods.

**PREVENTIVE MAINTENANCE**  
**for**  
**RATEMETER CD V-736 and DOSIMETER CD V-746**

The Bendix ratemeter and dosimeter are extremely sensitive instruments and although they are constructed for rugged use, they should receive the same care as a wristwatch. Since both instruments are hermetically sealed at the factory, they cannot be repaired or adjusted in the field, therefore, if malfunctioning of an instrument is experienced it should be returned to the factory or the nearest authorized service agency. Bendix ratemeters and dosimeters may be maintained in prescribed operating condition by simply cleaning the eye-piece lens and the charging switch insulator with clean water and a cloth free of lint and grit. Extra care should be taken to make sure the charging switch insulator is absolutely free of lint, dirt or moisture at all times.

**CAUTION:** Do not insert any sharp objects into, or tamper with parts in, the charging switch recess, as irreparable damage may be done to the instrument.

**A WORD ABOUT THE DIFFICULTY ("KICK")** sometimes experienced in zeroing the dosimeter and the ratemeter: the charging contact of the CDV-756 charger automatically compensates for the "kick" when the ratemeter is withdrawn *slowly* from the contact. You can see this effect by holding the ratemeter on the charging contact while looking into the instrument. Withdraw the instrument slowly. You will note that just before the light turns off the hairline will shift. With a little practice in setting the hairline slightly to the left of the zero line, the hairline can be made to shift so that its final position coincides with the zero line. Optimum performance is obtained when electrostatic "kick" is compensated for in this manner. The hairline will remain on or near the zero position for long periods when not exposed to radiation.

Hello!

If you are viewing this document on a CD purchased from an ebay seller you could have downloaded it for **FREE** at

[www.civildefensemuseum.com](http://www.civildefensemuseum.com)

Just thought you might like to know where this seller is getting their material.

Thanks

Eric Green

The Civil Defense Museum